

Residential and Commercial

ROOFING PRODUCT SOLUTIONS CATALOG



IPSTM
ROOFING PRODUCTS

QUALITY INNOVATION PERFORMANCE

IPS Corporation has long been recognized for its commitment to improving residential and commercial construction products. From introducing America's first plastic pipe solvent cement, the first plastic recessed Washing Machine Outlet Box, to the first adjustable multi-size roof vent flashing, IPS Corporation has always sought to help professional contractors work faster and smarter.

IPS leaves nothing to chance by using the highest-quality materials, which are fully tested for ultraviolet, ozone, and weather resistance. With continued devotion to research, product development, and superior service IPS will continue to bring innovative products with unsurpassed service to the roofing market.

IPS Corporation Roofing Products Division Focus:

.....
Creating value for our customers

.....
Product innovation

.....
Superior workmanship

.....
Unsurpassed customer service

.....
Professionalism at all levels
.....

Thank you for choosing IPS Corporation's Roofing Products!





GALVANIZED FLASHINGS

4N1 GALVANIZED BASE FLASHINGS



81711

- 4 sizes in 1 for on-the-job convenience – fits pipes 1¼" to 4"
- Large base and nailing flange for extra coverage in freeze-thaw climates
- Flexible PVC collar conforms to vent pipes to create a water-tight seal
- Limited Lifetime Warranty for the life of the current roof system

PRODUCT	DESCRIPTION	MODEL	UNITS/CASE
81711	4N1 12" x 16" Base – Mill Finish	GB41	20
81891	4N1 12" x 16" Base – Black	GB41BLACK	20
81890	4N1 12" x 16" Base – Brown	GB41BROWN	20
81892	4N1 12" x 16" Base – Gray	GB41GRAY	20
81880	4N1 18" x 18" Base – Mill Finish	GB4118	15

3N1® GALVANIZED STEEL BASE ROOF FLASHINGS



81710

- 24-gauge galvanized base
- Fits any roof pitch to 45° (1½" and 2" vent pipe allow for a pitch range beyond 45°)
- Tested for ultraviolet, ozone and weather resistance
- Approved for type "B" installations
- Elastomer collar heat tested to 180°F
- Multi-size flashing fits 1¼" – 3"
- Limited Lifetime Warranty for the life of the current roof system

PRODUCT	DESCRIPTION	MODEL	UNITS/CASE
81710	3N1® 10¾" x 14½" Base – Mill Finish	GB31	20
81851	3N1® 10¾" x 14½" Base – Brown	GB31BROWN	20
81852	3N1 10¾" x 13¼" Base – Black	GB31BLACK	20
81853	3N1 10¾" x 13¼" Base – Gray	GB31GRAY	20

STANDARD GALVANIZED STEEL BASE ROOF FLASHINGS



81850

- 24-gauge galvanized base with elastomer collar
- Fits any roof pitch to 45°
- Tested for ultraviolet, ozone and weather resistance
- Approved for type "B" installations
- Elastomer collar heat tested to 180°F
- Limited Lifetime Warranty for the life of the current roof system

PRODUCT	DESCRIPTION	MODEL	UNITS/CASE
81850	8¾" x 12½" Base for 1¼" or 1½" Vent Pipe	GB1	20
81855	8¾" x 12½" Base for 2" Vent Pipe	GB2	20
81860	10 ¾" x 14 ½" Base for 3" Vent Pipe	GB3	20
81865	12" x 16" Base for 4" Vent Pipe	GB4	20
81870	8¾" x 12½" Base for ½", ¾" or 1" Tubing	GB5	20

4N1 ALUMINUM BASE FLASHINGS

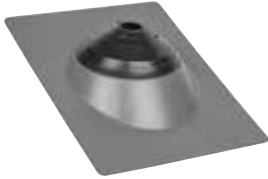

81895

- 4 sizes in 1 for on-the-job convenience – fits pipes 1¼" to 4"
- Large base and nailing flange for extra coverage in freeze-thaw climates
- Flexible PVC collar conforms to vent pipes to create a water-tight seal
- Limited Lifetime Warranty for the life of the current roof system

PRODUCT	DESCRIPTION	MODEL	UNITS/CASE
81716	4N1 12" x 16" Base – Mill Finish	AB41	20
81894	4N1 12" x 16" Base – Black	AB41BLACK	20
81893	4N1 12" x 16" Base – Brown	AB41BROWN	20
81895	4N1 12" x 16" Base – Gray	AB41GRAY	20
81934	4N1 18" x 18" Base – Mill Finish	AB4118	15

3N1® ALUMINUM BASE ROOF FLASHINGS



81715

- 25 mil aluminum base with elastomer collar
- Fits any roof pitch to 45° [1½" and 2" vent pipe allow for a pitch range beyond 45°]
- Tested for ultraviolet, ozone and weather resistance
- Approved for type "B" installations
- Elastomer collar heat tested to 180°F
- Multi-size flashings fits 1¼" – 3"
- Limited Lifetime Warranty for the life of the current roof system

PRODUCT	DESCRIPTION	MODEL	UNITS/CASE
81715	3N1® 10¾" x 14½" Base – Mill Finish	AB31	20
81901	3 N 1° 10¾" x 14½" Base – Brown	AB31BROWN	20
81902	3 N 1° 10¾" x 13¾" Base – Black	AB31BLACK	20
81903	3 N 1° 10¾" x 13¾" Base – Gray	AB31GRAY	20

STANDARD ALUMINUM BASE ROOF FLASHINGS



81915

- 25 mil. aluminum base with elastomer collar
- Fits any roof pitch to 45°
- Tested for ultraviolet, ozone and weather resistance
- Approved for type "B" installations
- Elastomer collar heat tested to 180°F
- Limited Lifetime Warranty for the life of the current roof system

PRODUCT	DESCRIPTION	MODEL	UNITS/CASE
81900	8¾" x 12½" Base for 1¼" or 1½" Vent Pipe	AB1	20
81905	8¾" x 12½" Base for 2" Vent Pipe	AB2	20
81910	10¾" x 14½" Base for 3" Vent Pipe	AB3	20
81915	12" x 16" Base for 4" Vent Pipe	AB4	20

HARD PLASTIC FLASHINGS

4N1 HARD PLASTIC BASE ROOF FLASHINGS



81709

- 4 sizes in 1 for on-the-job convenience – fits pipe 1 1/4" – 4"
- Larger base for extra coverage (12" x 16")
- Flexible PVC collar conforms to vent pipes to create a water-tight seal
- Backed by a life of the roof warranty

PRODUCT	DESCRIPTION	MODEL	UNITS/CASE
81709	4N1 Hardbase Flashing	HB41	20

3N1® HARD PLASTIC BASE ROOF FLASHINGS



81700

- Thermoplastic hard base with elastomer collar
- Fits any roof pitch to 45° (1 1/2" and 2" vent pipe allow for a pitch range beyond 45°)
- Tested for ultraviolet, ozone and weather resistance
- Approved for type "B" installations
- Elastomer collar heat tested to 180°F
- Multi-size flashing fits 1 1/4" – 3"
- Limited Lifetime Warranty for the life of the current roof system

PRODUCT	DESCRIPTION	MODEL	UNITS/CASE
81700	3 N 1® 11 1/8" x 15" Base	HB31	20

STANDARD HARD PLASTIC BASE ROOF FLASHINGS



81750

- Thermoplastic hard base with elastomer collar
- Fits any roof pitch to 45°
- Tested for ultraviolet, ozone and weather resistance
- Approved for type "B" installations
- Elastomer collar heat tested to 180°F
- Limited Lifetime Warranty for the life of the current roof system

PRODUCT	DESCRIPTION	MODEL	UNITS/CASE
81750	9 3/4" x 13" Base for 1 1/4" or 1 1/2" Vent Pipe	HB1	20
81751	11 1/8" x 15" Base for 1 1/4" or 1 1/2" Vent Pipe	HB1LB	20
81755	9 3/4" x 13" Base for 2" Vent Pipe	HB2	20
81756	11 1/8" x 15" Base for 2" Vent Pipe	HB2LB	20
81760	11 1/8" x 15" Base for 3" Vent Pipe	HB3	20
81765	12" x 15 1/2" Base for 4" Vent Pipe	HB4	20

Custom powder-coated colored flashings available, call customer service for availability.

Caution: Do not use Petroleum base mastics, sealing compounds or paints on collar portion of all flashings, on all hardbase, flexible or rain collars.

3N1® & 3N4 ALL FLEXIBLE ROOF FLASHINGS



81705

- All flexible, one-piece base and collar
- Fits any roof pitch to 45° (1 ½" and 2" vent pipe allow for a pitch range beyond 45°)
- Tested for ultraviolet, ozone and weather resistance
- Approved for type "B" installations
- Elastomer collar heat tested to 180°F

PRODUCT	DESCRIPTION	MODEL	UNITS/CASE
81705	3 N 1® 10" x 13 ¼" Base for 1 ¼", 1 ½", 2" or 3" Vent Pipe	FB31	20
81707	12" x 14 ¾" Base for 3" or 4" Vent Pipe	FB34	20

STANDARD ALL FLEXIBLE ROOF FLASHINGS



81800

- All flexible, one-piece base and collar
- Fits any roof pitch to 45°
- Tested for ultraviolet, ozone and weather resistance
- Approved for type "B" installations
- Elastomer collar heat tested to 180°F
- Limited Lifetime Warranty for the life of the current roof system

PRODUCT	DESCRIPTION	MODEL	UNITS/CASE
81800	9" x 11 ⅜" Base for 1 ¼" or 1 ½" Vent Pipe	FB1	20
81805	9" x 11 ⅜" Base for 2" Vent Pipe	FB2	20
81810	10" x 13 ¼" Base for 3" Vent Pipe	FB3	20
81815	12" x 14 ¾" Base for 4" Vent Pipe	FB4	20

COPPER FLASHING

4N1 COPPER BASE ROOF FLASHINGS



81942

- 16 ounce copper base with elastomer collar
- Fits any roof pitch to 45° (1 ½" and 2" vent pipe allow for a pitch range beyond 45°)
- Tested for ultraviolet, ozone and weather resistance
- Approved for type "B" installations
- Elastomer collar heat tested to 180°F
- Multi-size flashings fit 1 ¼" – 3" and 3" – 4" vent pipe
- Limited Lifetime Warranty for the life of the current roof system

PRODUCT	DESCRIPTION	MODEL	UNITS/CASE
81942	12" x 16" Base	CB41	5



MULTI-SIZE METAL ROOF PIPE FLASHINGS



81824

- Thermoplastic hard base with elastomer collar
- Fits any roof pitch to 45°
- Tested for ultraviolet, ozone and weather resistance
- Approved for type "B" installations
- Elastomer collar heat tested to 180°F
- Limited Lifetime Warranty for the life of the current roof system
- Ultraviolet and ozone-resistant EPDM rubber will not crack
- Clearly marked pipe diameters ensure a tight accurate fit
- Pleated cone adjusts to any roof pitch
- Continuous service temperature range of -65°F to 250°F

PRODUCT	DESCRIPTION	MODEL	UNITS/CASE
81820	1/4" – 2 1/2" EPDM Roof Flashing, 4 3/4" Base Diameter	81820	10
81821	1 3/4" – 3" EPDM Roof Flashing, 6 1/4" Base Diameter	81821	10
81822	1/4" – 5" EPDM Roof Flashing, 7 3/4" Base Diameter	81822	10
81823	3" – 6 1/4" EPDM Roof Flashing, 9 1/4" Base Diameter	81823	10
81824	4 1/4" – 7 3/4" EPDM Roof Flashing, 10 3/4" Base Diameter	81824	5
81825	5" – 9" EPDM Roof Flashing, 12 1/2" Base Diameter	81825	5
81827	7" – 13" EPDM Roof Flashing, 16 1/2" Base Diameter	81827	5
RETRO			
81828	3/4" – 2 3/4" EPDM Roof Flashing, 6 1/4" Base Diameter	81828	10

4N1 RAIN COLLARS



- Fits multiple size pipes with use of pull tab
- Fully tested for ultraviolet, ozone and weather resistance
- Large size covers the entire existing elastomer collar
- Eliminates the need for mastic or caulk
- Limited Lifetime Warranty for the life of the current roof system
- Can be used to instantly repair a leak during a wet period, until the flashing can be replaced at a later time
- Better appearance than a mastic repair job
- Can be used to repair the elastomer sealing collar on all types of residential "no caulk" roof vent flashings quickly and easily

PRODUCT	DESCRIPTION	MODEL	UNITS/CASE
81721	4N1® Collar for 1 1/4", 1 1/2", 2", 3" or 4" Vent Pipe	RC41	20

Custom powder-coated colored flashings available, call customer service for availability.

Caution: Do not use Petroleum base mastics, sealing compounds or paints on collar portion of all flashings, on all hardbase, flexible or rain collars.

SPECIALTY ROOFING PRODUCTS

STANDARD SIZE RAIN COLLARS



81725

- Fully tested for ultraviolet, ozone and weather resistance
- Eliminates the need for mastic or caulk
- Large size covers the entire existing elastomer collar
- Individual size and multi-size models available
- Limited Lifetime Warranty for the life of the current roof system
- Better appearance than a mastic repair job
- Can be used to instantly repair a leak during a wet period, until the flashing can be replaced at a later time
- Can be used to repair the elastomer sealing collar on all types of residential "no caulk" roof vent flashings quickly and easily

PRODUCT	DESCRIPTION	MODEL	UNITS/CASE
81725	Collar for 1 1/4" or 1 1/2" Vent Pipe	RC1	100
81730	Collar for 2" Vent Pipe	RC2	100
81735	Collar for 3" Vent Pipe	RC3	75
81740	Collar for 4" Vent Pipe	RC4	75
81745	Collar for 1/2", 3/4", 1" Vent Pipe/25 bag	RC5	100

LOW-PROFILE RAIN COLLARS



81739

- Low-profile size
- For all metal style roof flashings
- Designed to fit all metal coned roof jacks/flashings 1"–4"
- Manufactured using a special EPDM material with UV inhibitor
- Limited Lifetime Warranty for the life of the current roof system
- Requires no mastic, caulking or taping for a total waterproof seal

PRODUCT	DESCRIPTION	MODEL	UNITS/CASE
81739	Low Profile Collar for 1" Vent Pipe (25 bag)	LPC1	100
81741	Low Profile Collar for 1 1/2" Vent Pipe (25 bag)	LPC15	100
81742	Low Profile Collar for 2" Vent Pipe (25 bag)	LPC2	100
81743	Low Profile Collar for 3" Vent Pipe (25 bag)	LPC3	100
81744	Low Profile Collar for 4" Vent Pipe (25 bag)	LPC4	100



Collar only.
Flashing not included.

SOLAR ROOFING PRODUCTS



81870

- Commercial & residential: water-tight seal for solar mounting system
- Requires no mastic, caulking or taping – mess free
- Limited Lifetime Warranty for the life of the current roof system

PRODUCT	DESCRIPTION	MODEL	UNITS/CASE
81870	8 3/4" x 12 1/2" Base for 1/2", 3/4" or 1" Tubing	GB5	20
81879	18" x 18" Base for 1/2", 3/4" or 1" Tubing	GB518	15
81916	8 3/4" x 12 1/2" Base for 1/2", 3/4" or 1" Tubing	AB5	20
81937	18" x 18" Base for 1/2", 3/4" or 1" Tubing	AB518	15

ELECTRICAL MAST ROOF FLASHING



81731

- Constructed of UV stabilized flexible PVC with proven track record of 40 years
- Tongue and groove design for increased weather protection
- Equipped with multi-piece stainless steel clamps
- Clamps for easier installation
- Available in two sizes
- Warrantied for the life of the roof system

PRODUCT	DESCRIPTION	MODEL	UNITS/CASE
81731	Electrical Mast RetroFit Roof Flashing, 0 to 31/2" – 13 3/4" x 11" Base	EFB1	15
81732	ctrical Mast RetroFit Roof Flashing, 0 to 5" – 14" x 15" Base	EFB2	15

MULTICAP™ B-VENT CAP



81694

- Recommended for flue, hot stack or b-vent installations
- Non-clogging positive draft design
- Clamp fittings adjustable for all standard sizes
- Aluminum construction
- Complies with ANSI / UL 441

PRODUCT	DESCRIPTION	MODEL	UNITS/CASE
81694	For outside diameters of 2 7/8" to 4 7/8"	VC35	12
81695	For outside diameters of 4 7/8" to 6 7/8"	VC57	12
81696	For outside diameters of 6 7/8" to 8 7/8"	VC79	12
81697	For outside diameters of 8 7/8" to 10 7/8"	VC911	1
81698	For outside diameters of 11 7/8" to 14"	VC1214	1

IMPROVE YOUR EAVE INTAKE

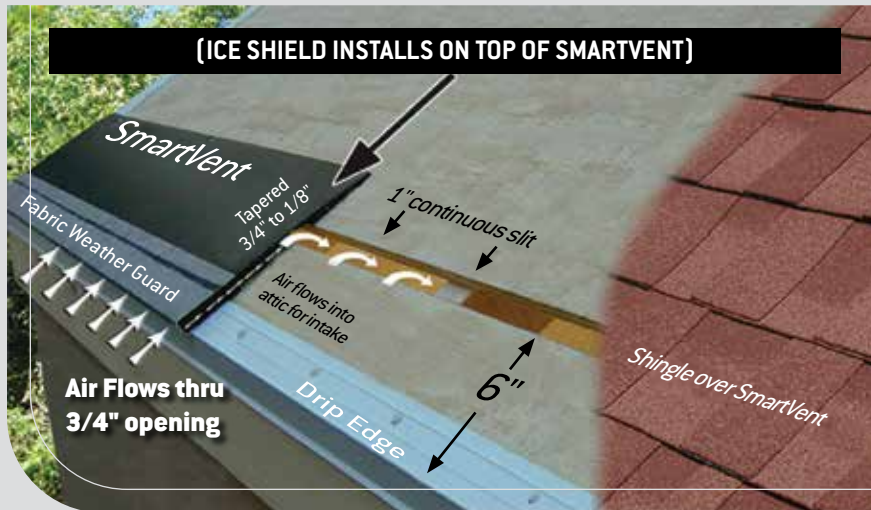

EASIER INSTALL

SmartVent™ is light weight, nail gunnable, easy to cut with a knife and keeps the roofer on the roof.

LIFETIME WARRANTY

SmartVent™ carries a warranty for the lifetime of the roof on which it is installed.

UNMATCHED VERSATILITY

SmartVent™ offers a continuous venting area that can be used all the way up the roof from eave to ridge.

BETTER SOLUTION

SmartVent™ is unnoticeable from the ground, provides cross-channel airflow to the exhaust vents and is an alternative for soffits that could be blocked.

ICC-ES APPROVED

ESR-2484

SmartVent Off Peak

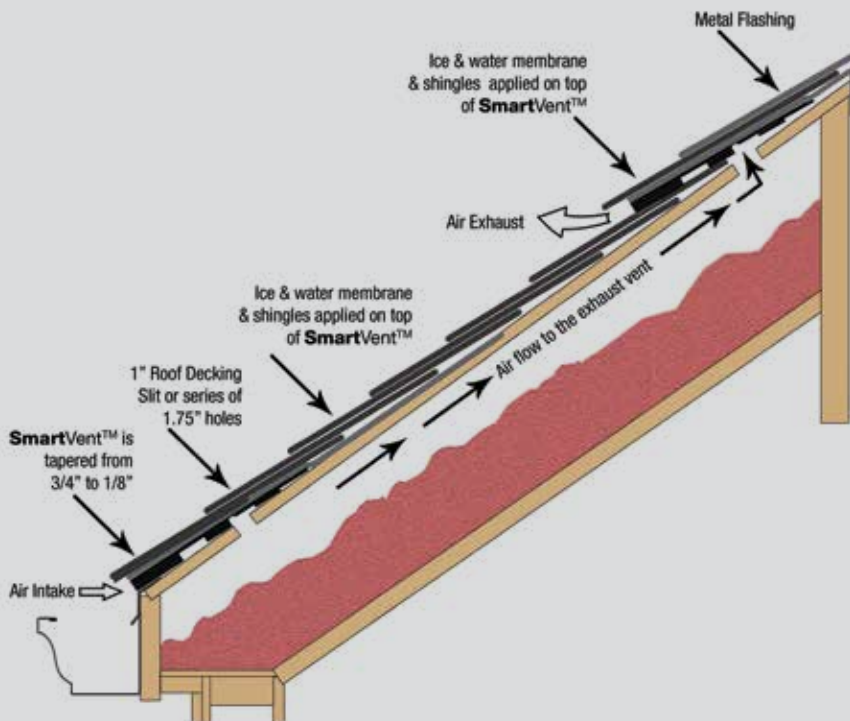

SMARTVENT™ ATTIC INTAKE & EXHAUST

SMARTVENT™



- Use on eaves, mid-roof, off-wall, shed-wall, off-peak, dormer and valley
- Intake or exhaust for all climates
- 9 square inches of NFA per linear foot (18 when used on both sides)
- Tapered for a natural look
- Fabric mesh guards against rain and snow infiltration

PRODUCT	DESCRIPTION	MODEL	UNITS/CASE
80750	SmartVent™	SV1	18

SMARTVENT™ END CAPS



- Provides a perfectly tapered end to SmartVent™
- Eliminates the need to fabricate end caps on the job
- Fabric mesh guards against rain and snow infiltration
- Seamless fit to SmartVent™ for continuous airflow in all directions

PRODUCT	DESCRIPTION	MODEL	UNITS/CASE
80751	SmartVent™ End Caps	SVEC	12

THE ALL-PURPOSE INTAKE & EXHAUST SOLUTION

MID-ROOF & OFF WALL

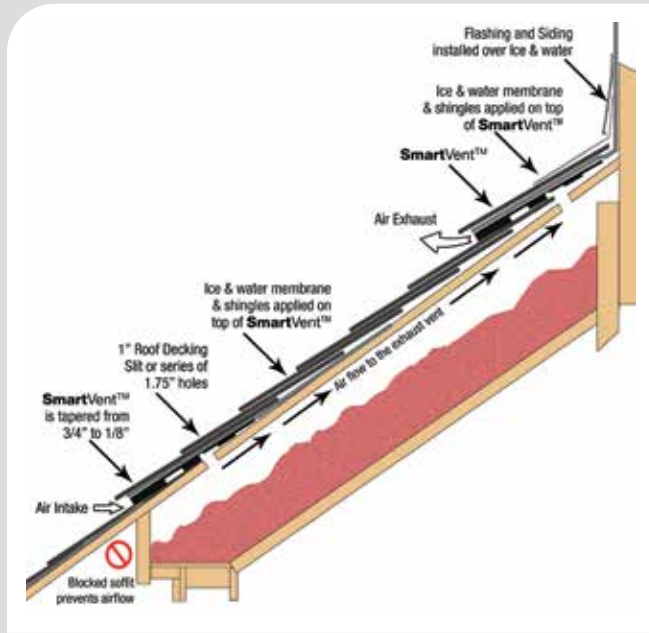

SHED ROOF

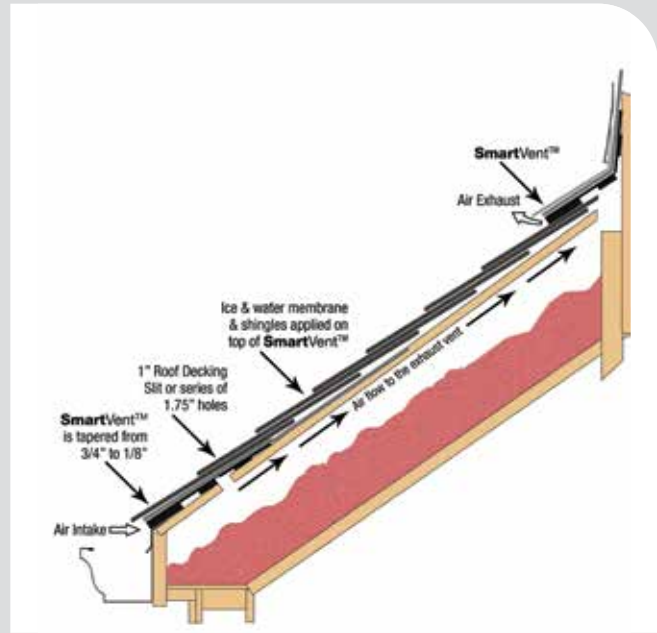

DORMER PEAK

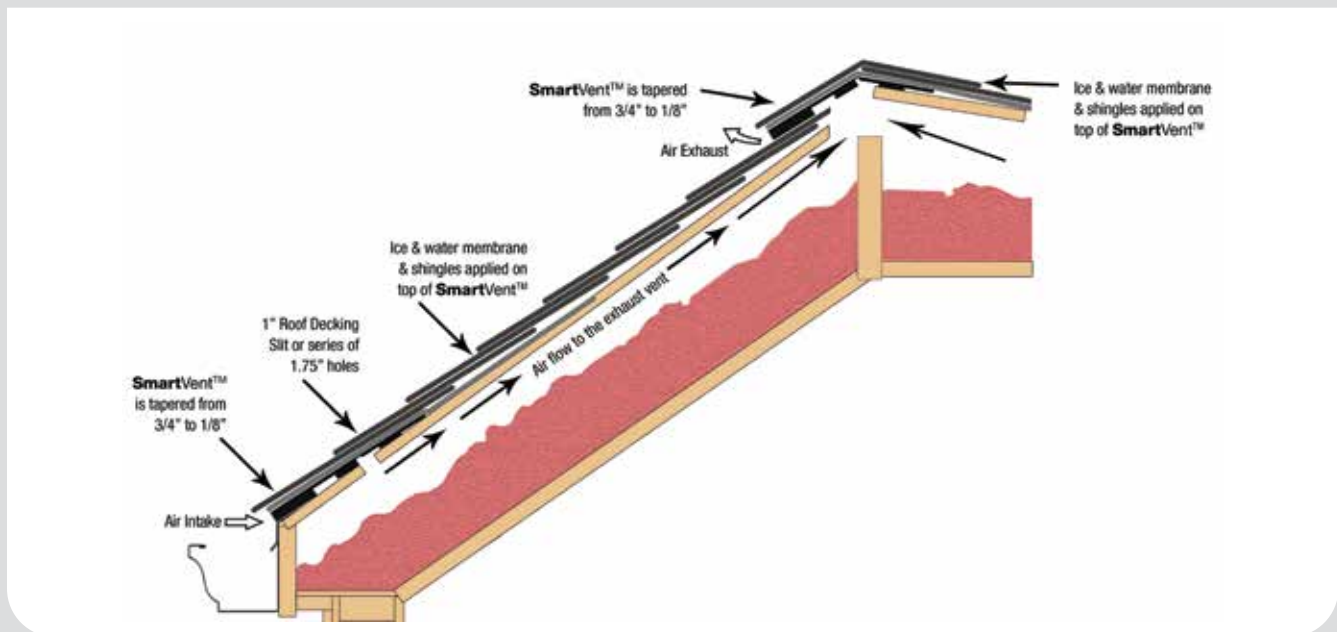

SmartRidge™ I

One Sided Ridge Ventilation

IPS SmartRidge™ I is the most efficient ridge exhaust system. By exhausting air on one side, the SmartRidge™ I siphons 100% attic exhaust without pulling in exterior air, rain, snow or ice from the opposite side of the vent. The SmartRidge™ I produces a natural look with no street side lift making it the most effective and cleanest looking ridge vent system.

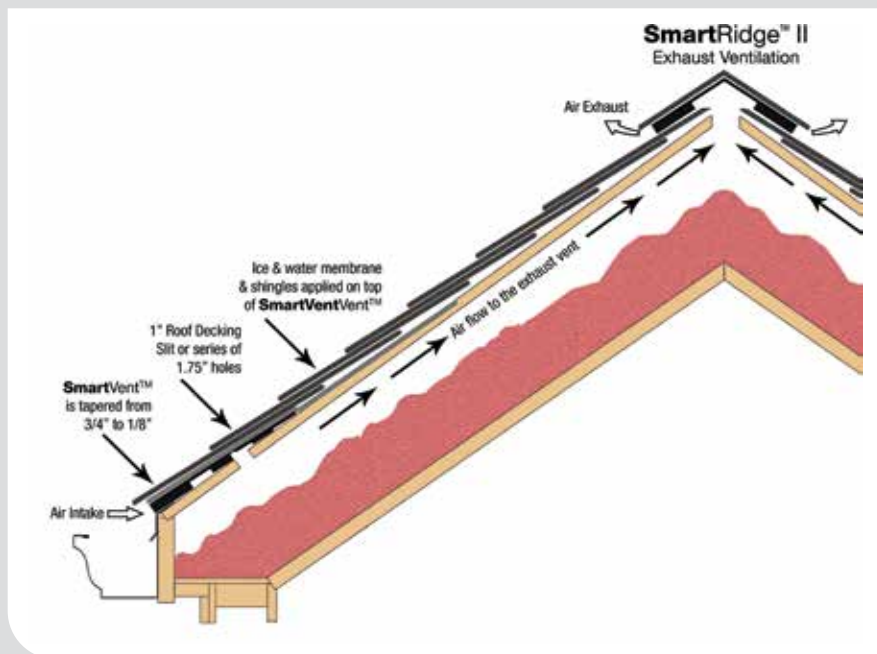
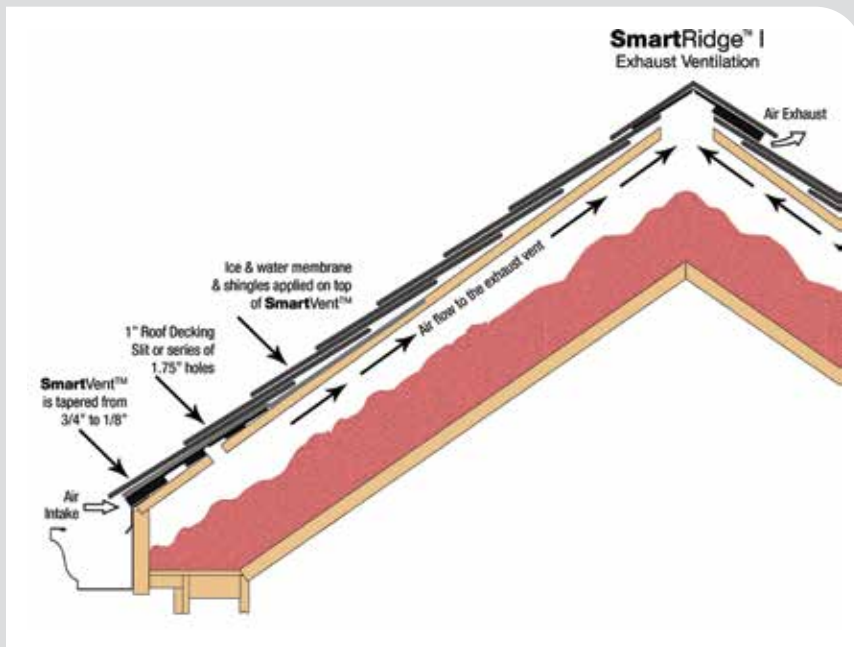
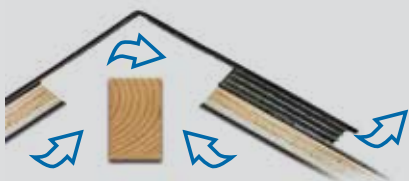

SmartRidge™ II

Two Sided Hip & Ridge Ventilation

IPS SmartRidge™ II is a versatile vent that can be used for hip and ridge ventilation. Equipped with protective weather fabric, the SmartRidge™ II prevents rain, sleet and snow from penetrating the attic and damaging the roof structure. SmartRidge™ II cuts with a utility knife and can be hand or nail gunned for easy install.

SMARTRIDGE™ HIP & RIDGE VENTILATION

SMARTRIDGE™ I



- 100% attic exhaust
- No street side lift for improved appearance
- Fabric mesh guards against rain and snow infiltration
- Equivalent to 18 square inches of NFA
- Achieves a balanced ventilation system with SmartVent™
- Easy to cut and install

PRODUCT	DESCRIPTION	MODEL	UNITS/CASE
80752	SmartRidge™ I	SR1	16

SMARTRIDGE™ II

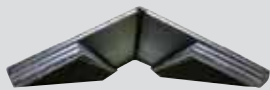

- Fabric mesh guards against rain and snow infiltration
- 18 square inches of NFA
- Achieves a balanced ventilation system with SmartVent™
- Easy to cut and install

PRODUCT	DESCRIPTION	MODEL	UNITS/CASE
80753	7" SmartRidge™ II	SR27	24
80754	8.5" SmartRidge™ II	SR285	16
80755	10.5" SmartRidge™ II	SR2105	12

VALLEYVENT™ VALLEY, RAFTER & DECK VENTILATION

VALLEYVENT™

The IPS ValleyVent™ installs between the rafters and roof deck and allows airflow around valleys, skylights, hip roofs, and other difficult areas to ventilate. The ValleyVent™ increases the efficiency of the roof's ventilation, allowing for continuous airflow throughout the roof system. This prevents build-up in "hot spots" where airflow commonly faces obstructions that can lead to inadequate airflow, ice dams, and mold growth.

VALLEYVENT™



- Provides airflow in difficult-to-ventilate and obstructed areas
- Polyethylene construction is easy to handle and install
- Helps prevent ice dams, "hot spots" and mold growth
- Increases the efficiency of the ventilation system

PRODUCT	DESCRIPTION	MODEL	UNITS/CASE
80756	ValleyVent™	VV1	84

SnapCap™

Bathroom, Kitchen, & Dryer Exhaust Vent Cap

SnapCap™ is the highest performance, most versatile bathroom, kitchen, and dryer exhaust vent cap available. Equipped with a counterbalanced damper, SnapCap works with any CFM fan and provides a secure connection to 3", 4" and 6" flexible or rigid duct. SnapCap™ is constructed of heavy gauge aluminum or galvanized steel to provide unmatched durability and is backed by a Life of the Roof™ warranty. Each SnapCap™ package includes an adapter set and cable tie.

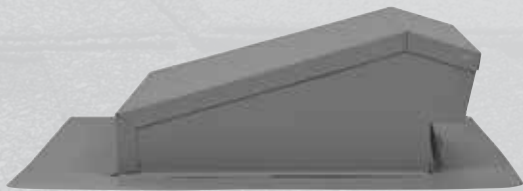

Low-Profile, Durable Gauge Design

SnapCap™ has a lower profile on the roof and a heavier gauge base and housing for improved aesthetics and increased performance. SnapCap™ is available in aluminum and galvanized steel.

Easy "Snap-In" Installation

SnapCap™ adapters easily snap into the vent cap for a secure connection.



Brown



Black



Gray

Three Powder-Coated Finishes Available

SnapCap™ is available in black, brown, and weathered gray to match most roofing systems.

Easily connect ductwork with a cable tie, duct tape, or a sheet metal screw

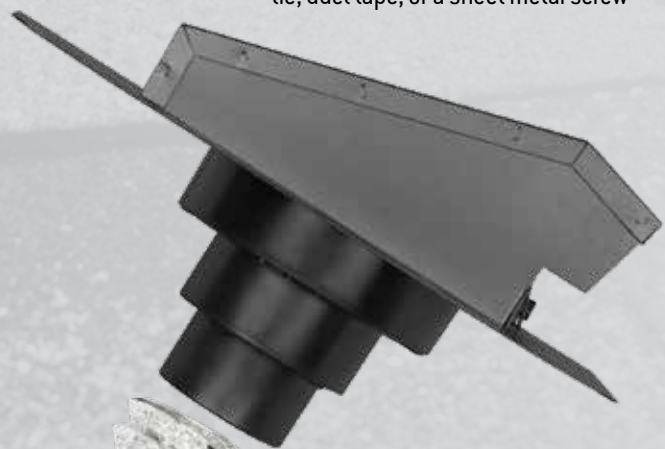

GALVANIZED STEEL SNAPCAP™

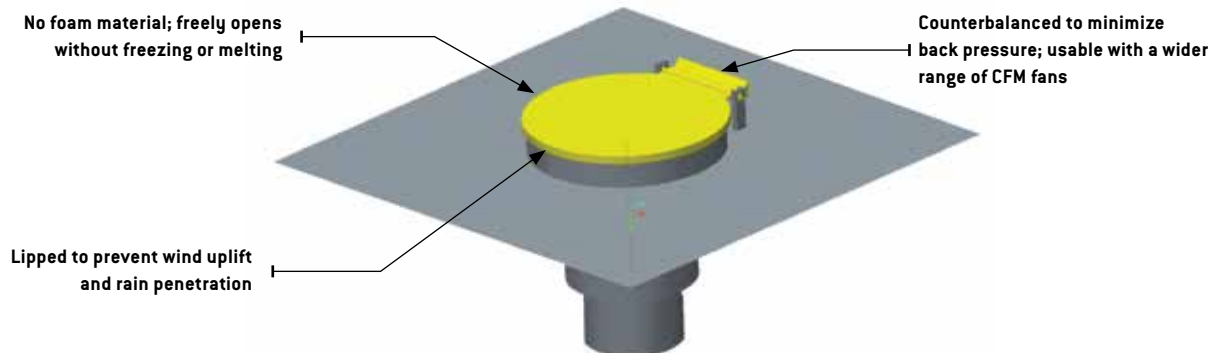

GALVANIZED STEEL SNAPCAP™



81681

- All-Flow™ capability: patent pending counterbalanced damper works with any CFM fan
- 3", 4", & 6" adapters for multiple application sizes
- Heavy gauge flange and housing
- Three powder coated finishes available
- Adapter set and cable tie included with each SnapCap™

PRODUCT	DESCRIPTION	MODEL	UNITS/CASE
81680	 SnapCap – Brown Galvanized Steel	SCBRG	1
81681	 SnapCap – Black Galvanized Steel	SCBLG	1
81682	 SnapCap – Weathered Gray Galvanized Steel	SCGRG	1

ALUMINUM SNAPCAP™



81683

- All-Flow™ capability: patent pending counterbalanced damper works with any CFM fan
- 3", 4", & 6" adapters for multiple application sizes
- Heavy gauge flange and housing
- Three powder coated finishes available
- Adapter set and cable tie included with each SnapCap™

PRODUCT	DESCRIPTION	MODEL	UNITS/CASE
81683	 SnapCap – Brown Aluminum	SCBRAL	1
81684	 SnapCap – Black Aluminum	SCBLAL	1
81685	 SnapCap – Weathered Gray Aluminum	SCGRAL	1

IPS VENTILATION OVERVIEW

WHY IPS VENTILATION?

A properly ventilated attic is essential to lowering energy costs, preventing damaging mold, condensation and ice dams and extending the life of the roof. Attics need to “breathe” using a balanced system of roof intake and exhaust ventilation.

Proper attic ventilation allows insulation to function more efficiently and keeps hot air and moisture out. In colder climates, proper ventilation balances the temperature of the roof which is key to ice dam prevention. This extends the life of the roof deck, shingles and attic structure and lowers home energy costs.

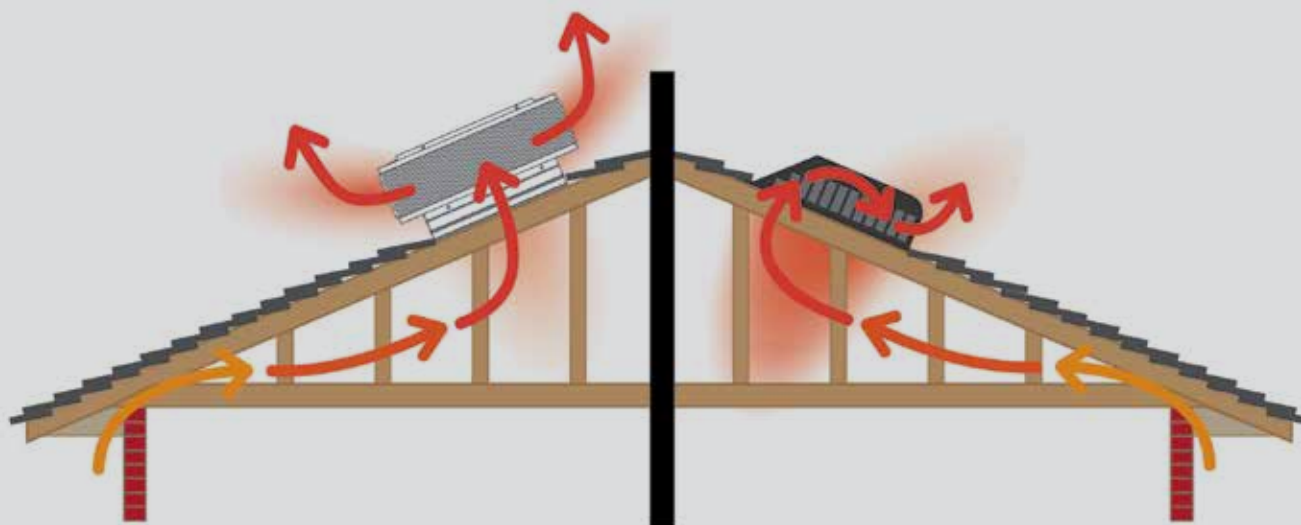

IPS Ventilation pulls air out of the attic

These innovative round designs utilize the Venturi Effect; by using exterior wind to create suction, IPS vents pull hot or moist air out of the attic more effectively than any other static vent.

IPS Ventilation allows air to flow out of the attic unobstructed

Static vents are judged by Net Free Area (NFA), the open area designed for air to pass through a vent. While most vents are rated a certain NFA, they do not all allow air to easily escape due to redirections and obstructions. IPS ventilation NFA is true NFA, allowing air to flow the path of least resistance without being restricted.

IPS Ventilation products have superior durability

IPS ventilation bases are constructed with a thicker gauge aluminum than standard static attic vents. They won't be damaged during shipping or buckle when you nail them and are guaranteed to last for the life of the roof*.

**All static IPS vents are warranted for the life of the roof. Compact Solar™ Roof Fans are warranted for 5 years. Visit IPSRoofingProducts.com for full warranty statements.*

**Most building codes require a minimum of one square foot of net free venting area per 150 square feet of attic floor area. Always consult your local building code for proper installation guidelines*

360™ ROOF VENT



80701

- Heavy gauge, all-aluminum construction will not rust
- Round design uses exterior air to dynamically pull air from the attic
- 8" opening is perfect for replacement of slant-back vents and other static vents
- 50 sq. in. of NFA (Net Free Area)
- Design allows air to flow freely with no obstructions or redirections
- Cap acts as umbrella for increased weather protection
- Louver design deflects rain, snow and other debris
- Limited lifetime warranty for the life of the current roof system

PRODUCT	DESCRIPTION	MODEL	UNITS/CASE
80700	 Round Back Vent – Gray	360GRAY	7
80701	 Round Back Vent – Black	360BLACK	7
80702	 Round Back Vent – Brown	360BROWN	7

COMMERCIAL ROOFING PRODUCTS

APE-2000 ONE-WAY AIR PRESSURE EQUALIZER



99100

DIMENSIONS:

Height: 11.25"
 Base Diameter: 11.00"
 Stack Diameter: 6.00"
 Cap Height: 4.25"

Recommended for all types of roofing systems.

NOTE: Available with or without one-way insert. Also available with removable caps (please specify).

- .063 gauge aluminum
- "One-way air pressure equalizer" vent system
- Constructed of heavy gauge aluminum
- Fully insulated to eliminate condensation
- Engineered to withstand extended exposure to the elements without deterioration
- Will reduce the risk of ballooning, blow-offs, graver spreading, deterioration of roof insulation and deck seam separation
- 20-year warranty

PRODUCT	DESCRIPTION	MODEL	UNITS/CASE
99100	APE 2000 W/Tite-Top & Insulator, One Way	APE2000WTT	4
99101	APE 2000 W/Tite-Top No Insulator, Two Way	APE2000WOTT	4
99102	APE 2000 W/Removeable Top & Insulator, One Way	APE2000WRT	4
99103	APE 2000 W/Removeable Top, No Insulator, Two Way	APE2000WORT	4

BALLARD JL-10 ONE-WAY VENT



99104

DIMENSIONS:

Height: 9.75"
 Base Diameter: 11.25"
 Stack Diameter: 4.00"
 Cap Height: 1.50"

Recommended for all types of roofing systems. Install one vent per 900 sq. ft. of roof area.

- .063 gauge aluminum
- "One-way" vent system
- Constructed of heavy gauge aluminum, and fully insulated to eliminate condensation
- One piece spun aluminum construction eliminates the possibility of split seams and blown off caps
- Layer of one-way fabric allows moisture and air to escape, but not to enter the roofing system
- Unlike other vents on the market, there are no moving parts to wear out or clog due to insects or debris
- 20-year warranty

PRODUCT	DESCRIPTION	MODEL	UNITS/CASE
99104	Ballard JL-10 W/Tite-Top & Insulator, One Way	JL10	10

JIMCO SJL-3 ECONOMY VENT



99106

DIMENSIONS:

Height: 8.50"
 Base Diameter: 8.00"
 Stack Diameter: 3.00"
 Cap Height: 2.50

Recommended for all types of roofing systems. Install one vent per 900 sq. ft. of roof area.

NOTE: Available with or without one-way EPS insert (please specify)

- .063 gauge aluminum
- "Economy one-way" vent system
- Constructed of heavy gauge aluminum
- Fully insulated to eliminate condensation
- Layer of one-way fabric that allows moisture and air pressure to escape, but not enter the roofing system
- Factory secured Tite Top design omits any possibility of backwash and cannot become detached from the main stack
- 20-year warranty
- JIMCO LT

PRODUCT	DESCRIPTION	MODEL	UNITS/CASE
99105	SJL-3 W/Tite-Top & Insulator, One-Way	SJL3W	20
99106	SJL-3 W/Tite-Top & Insulator, Two-Way	SJL3W0	20

JIMCO LT-6 ONE-WAY AIR PRESSURE EQUALIZER



99107

DIMENSIONS:

Height: 6.50"
 Base Diameter: 10.25"
 Stack Diameter: 6.00"
 Cap Height: 4.25"

Recommended for all types of roofing systems. Used also as a mobile home and trailer fan replacement vent.

- .063 gauge aluminum
- Designed to withstand extended pressure and air moisture trapped within the roofing system, for the purpose of allowing pressure (air moisture) to escape
- Constructed of heavy spun aluminum
- 20-year warranty

PRODUCT	DESCRIPTION	MODEL	UNITS/CASE
99107	LT-6 W/Tite Top & Insulator, One Way	LT6WTT	8
99108	LT-6 W/Tite Top, No Insulator, Two Way	LT6WOTT	8
99109	LT-6 W/Removable Top & Insulator, One Way	LT6WRT	8
99110	LT-6 W/Removable Top, No Insulator, Two Way	LT6WORT	8

COMMERCIAL ROOFING PRODUCTS

JIMCO BREATHER VENT



99111

DIMENSIONS:

Height: 9.50"

Base Diameter: 11.00"

Stack Diameter: 4.25"

Cap Height: 2.50"

Recommended for all types of roofing systems. Install one vent per 1000 sq. ft. of roof area

- .063 gauge aluminum
- Constructed of a heavy gauge spun aluminum
- Designed to withstand prolonged exposure to the toughest elements without deterioration
- Cap has been engineered to eliminate any possibility of backwash
- Cannot become detached from the main stack, protecting it from the possibility of exposing breather holes to the elements
- 20-year warranty

PRODUCT	DESCRIPTION	MODEL	UNITS/CASE
99111	Jimco Breather Vent, Two-Way	JIMCO	10

JIMCO VJ-2 ONE PIECE VENT



99115

DIMENSIONS:

Height: 5.50"

Base Diameter: 10.25"

Stack Diameter: 6.00"

Cap Height: 1.20"

Recommended for all types of roofing systems. Install one vent per 1100 sq. ft. of roof area.

- .063 gauge aluminum
- Constructed of one piece heavy gauge spun aluminum
- Designed and fabricated to withstand extended exposure to the toughest elements without deterioration
- Low profile vent versatile for application on mobile homes, house trailers, etc.
- Large stack capacity able to handle a great amount of pressure from built-up or single ply roofs
- 20-year warranty

PRODUCT	DESCRIPTION	MODEL	UNITS/CASE
99115	VJ-2, Two-Way	VJ2	10

JIMCO CJ-30 VENT



99112

DIMENSIONS:

Height: 5.50"
 Base Diameter: 10.25"
 Stack Diameter: 6.00"
 Cap Height: 1.20"

Recommended for all types of roofing systems. Install one vent per 600 sq. ft. of roof area.

NOTE: Also available with removable cap (please specify).

- .063 gauge aluminum
- Constructed of heavy gauge spun aluminum
- Designed to withstand extended exposure to the toughest elements without deterioration
- Cap has been engineered to eliminate any possibility of backwash
- Cannot become detached from the main stack, protecting from the possibility of exposing the breather holes
- 20-year warranty

PRODUCT	DESCRIPTION	MODEL	UNITS/CASE
99112	CJ-30 W/Removable Top, Two-Way	CJ30RT	20
99113	CJ-30 W/Tite-Top, Two-Way	CJ30TT	20

JIMCO HT-20 LOW PROFILE VENT



99114

DIMENSIONS:

Height: 5.50"
 Base Diameter: 6.00"
 Stack Diameter: 3.00"
 Cap Height: 2.50"

Recommended for all types of roofing systems. Install one vent per 200 sq. ft. of roof area.

- .063 gauge aluminum
- Low profile vent, mainly used in new construction of mobile homes, house trailers and also in the re-roofing industry
- Manufactured of a heavy gauge spun aluminum
- Cap design will not allow backwash
- 20-year warranty

PRODUCT	DESCRIPTION	MODEL	UNITS/CASE
99099	HT-20 With Tite Top, Two-Way	"HT20TT"	50
99114	HT-20 With Removable Top, Two-Way	"HT20"	50

ROOF DRAIN KIT



86096

Kits Include: Drain, underdeck clamp with hardware, expansion coupling, 4" section of PVC pipe and installation guide

- Heavy duty plastic body
- 3" and 4" pipe sizes
- Clamping ring/gravel guard standard on all drains
- Two-piece underdeck clamp kits
- Accepts Schedule 40 pipe
- Available with Cast Iron Domes
- 20-year warranty

PRODUCT	DESCRIPTION	MODEL	UNITS/CASE
86096	3" PVC Roof Drain W/Cast Iron Dome	4863K"	1
86106	4" PVC Roof Drain W/Cast Iron Dome	4864K"	1

COMMERCIAL ROOFING PRODUCTS

RETROFIT INSERT ROOF DRAINS



86111

DIMENSIONS:

Height: 5.50"
 Base Diameter: 6.00"
 Stack Diameter: 3.00"
 Cap Height: 2.50"

Recommended for all types of roofing systems. Install one vent per 1000 sq. ft. of roof area

- RetroFit drains with expandable anti-back-up seal(s)
- Constructed of a heavy gauge (.081)
- Spun Aluminum
- Bolt-in-place strainer dome
- 20-year warranty

PRODUCT	DESCRIPTION	MODEL	UNITS/CASE
86111	Drain Pipe Size: 3" Outlet Outside Diameter: 2.75" Outlet Length: .727"	86111	6
86112	Drain Pipe Size: 4" Outlet Outside Diameter: 3.75" Outlet Length: .727"	86112	6
86113	Drain Pipe Size: 6" Outlet Outside Diameter: 5.75" Outlet Length: .727"	86113	6

COMMERCIAL ROOF DRAINS & ACCESSORIES



86125



86125



87580

PRODUCT	DESCRIPTION	MODEL	UNITS/CASE
86115	3" PVC Roof Drain W/Plastic Dome	4865	1
86120	3" ABS Roof Drain W/Plastic Dome	5865	1
86095	3" PVC Roof Drain W/Cast Iron Dome	4863	1
86100	3" ABS Plastic Roof Drain W/Cast Iron Dome	5863	1
86121	4" PVC Roof Drain W/Plastic Dome	4866	1
86122	4" ABS Roof Drain W/Plastic Dome	5866	1
86105	4" PVC Roof Drain W/Cast Iron Dome	4864	1
86110	4" ABS Plastic Roof Drain W/Cast Iron Dome	5864	1
86125	Underdeck Clamping Collar W/ Hardware, 3" or 4" Roof Drain	5555	1
89522	Plastic Dome	89522	5
89527	Cast Iron Dome	89527	5
87580	3" Rubber Expansion Coupling	87580	20
87585	4" Rubber Expansion Coupling	87585	20

CAST IRON ROOF DRAIN



60213

- 6 ½" dome
- Available with bottom or side outlet
- Limited Lifetime Warranty for the life of the current roof system

PRODUCT	DESCRIPTION	MODEL	UNITS/CASE
60213	3" No-hub Bottom Outlet	ABA573	1
60214	4" No-hub Bottom Outlet	ABA574	1
60215	2" No-hub Side Outlet	ABA582	1
60216	3" No-hub Side Outlet	ABA583	1

CAST IRON ROOF DRAIN



60219

DIMENSIONS:

Height: 5.50"
Base Diameter: 6.00"
Stack Diameter: 3.00"
Cap Height: 2.50"

- Overflow combo
- 8 ¾" CD
- 6 ½" dome
- Limited Lifetime Warranty for the life of the current roof system

PRODUCT	DESCRIPTION	MODEL	UNITS/CASE
60219	2" No-hub Outlet	ABA602	1
60220	3" No-hub Outlet	ABA603	1
60222	4" No-hub Side Outlet	ABA604	1
60218	6 ½" Dome with Ring & Hardware	ABA586	1

HAND CLEANER



12762

WIPES

- Advanced hand cleaner in disposable wipe format for removing residual solvent cements (PVC, CPVC, ABS), primers and sealants, dirt, oil, grease and much more

PRODUCT	DESCRIPTION	MODEL	UNITS/CASE
12762	Hand Cleaner Wipes-72 Pack	002110000	6



IPS Corporation

500 Distribution Parkway
Collierville, TN 38017

800-888-8312
901-853-5008 fax

IPSRoofingProducts.com

plumbing@ipscorp.com

R00F001 06/2022